

gizir[®]
WOOD PRODUCTS

3D PANEL



What is 3D PANEL?

3D Panel is our newest innovative solution for premium interior furniture. MDF is first laminated with a foam layer. Then, foam laminated MDF is covered with the desired foil. As the last step, pressure is applied on the panel to give it the desired 3D design.

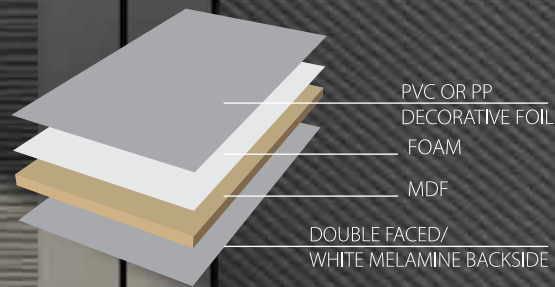

**DOUBLE FACED/
WHITE MELAMINE
BACKSIDE**

PANEL DIMENSIONS

Width	1220mm
Length	2800mm
Thickness	18/10mm

*thickness options available

COLOR & DECORS



S010 | S.M. White

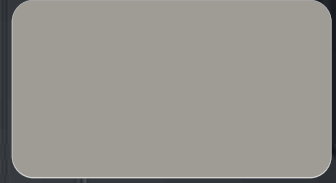

S027 | S.M. Mink

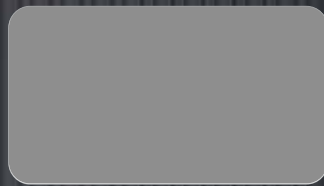

S028 | S.M. Light Grey

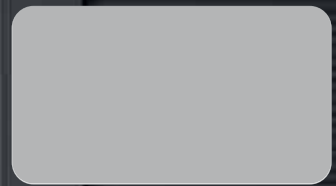

S034 | S.M. Winter Gates

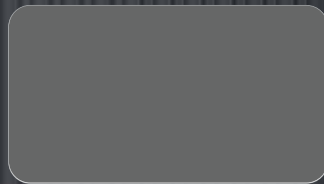

S036 | S.M. Dark Grey



S038 | S.M. Dust Grey

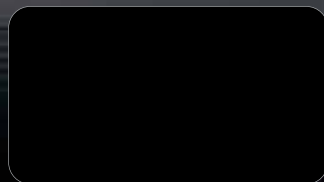

S040 | S.M. Black

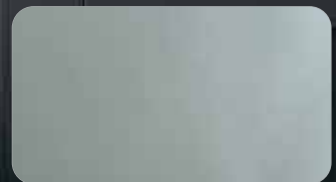

4040 | Silver

* Please ask for more color options.



6 Design Options

available in MATT & SUPERMATT



3D01

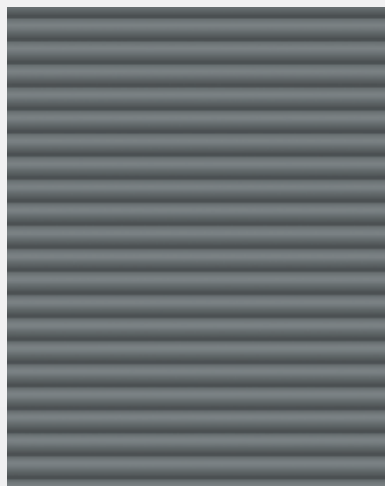
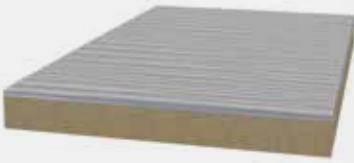

3D02

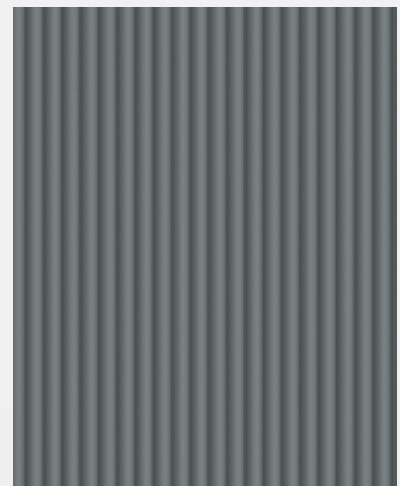

3D03



3D04

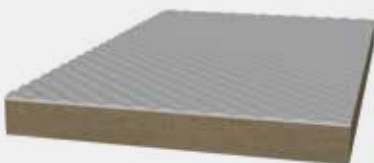

3D05

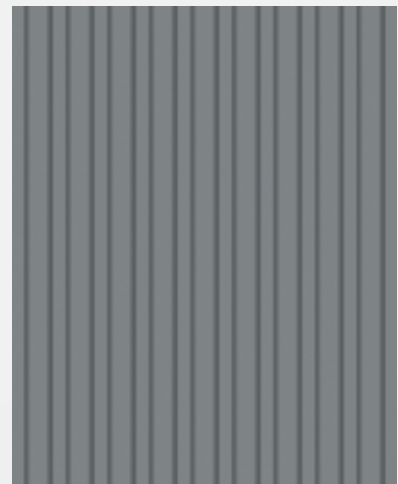
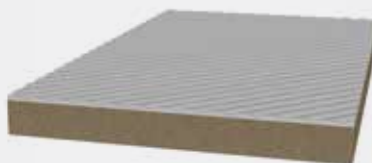

3D06



*Custom designs can be made upon request.

*Aluminium J handles of same color & foils are available.

Accessories

ALUMINIUM
J HANDLE
PROFILE

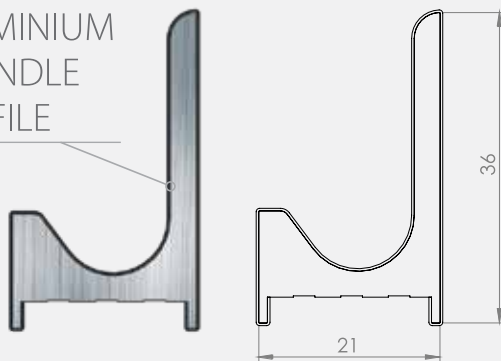

J HANDLE PROFILES (mm)

Length	2800
Width	21

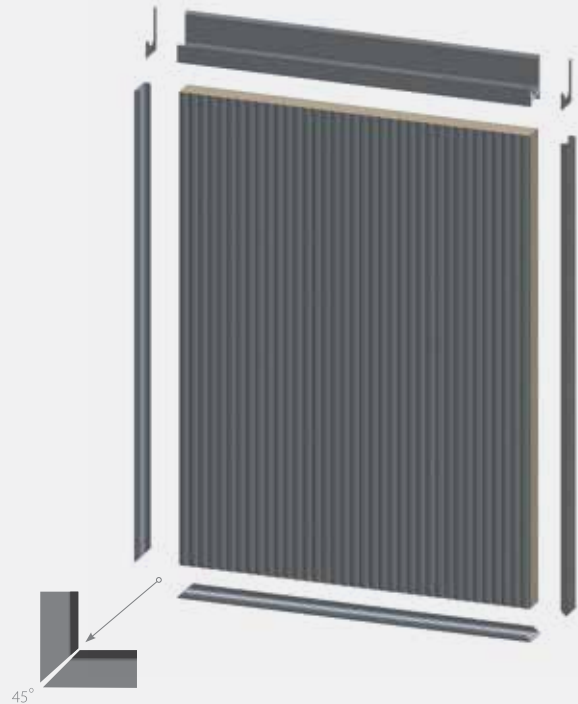

How to FINISH THE SIDES?

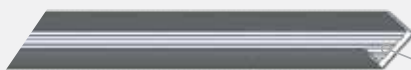

ALUMINIUM SIDE PROFILE



MDF SIDE PROFILE

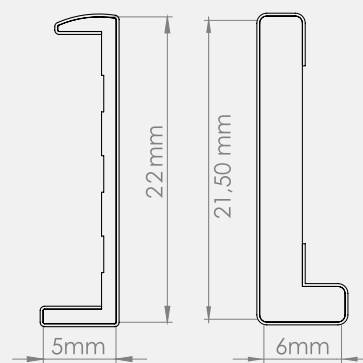

SIDE PROFILES (mm)

Length	2800
Width	22 / 21,5

Instead of regular edgebanding, aluminium or MDF edge profiles of same color & foil are used to achieve a cleaner & more elegant look. Accessories can be applied by using PU transparent mounting adhesive in the applications of both J handle and aluminium edge profiles.

Accessories can be applied by using PU transparent mounting adhesive in the applications of both J handle and aluminium edge profiles.

*Custom designs can be made upon request.

*Aluminium J handles of same color & foils are available.

1

If aluminium edge profiles are going to be used for all 4 sides, they should be cut in a 45° angle.

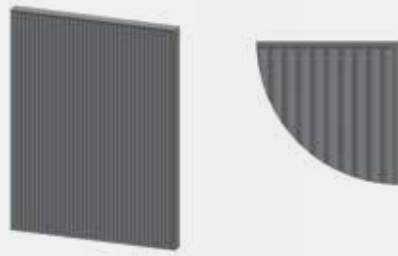

2

If the aluminium J handle is going to be applied on 1 side, the length of it should be 0.4 mm less than the side that is going to be applied on.

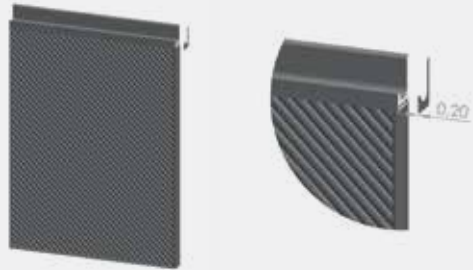

3

The length of the 2 aluminium edge profiles that are going to be applied on the neighbouring sides of the J handle should be 3mm less than the side that they are going to be applied on.

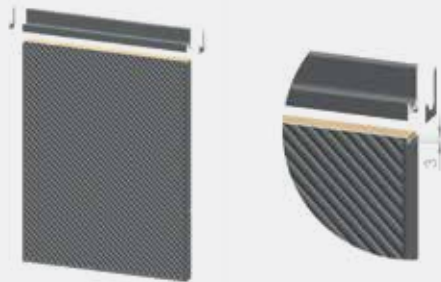

4

Peel off the protective foil from the panel.

5

2 aluminium edge profiles that are going to be applied on the neighbouring sides of the J handle should be cut in a 45° angle from only one end.

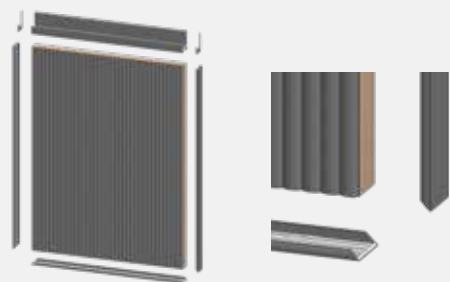

6

Side of the J handle is advised to be covered with the special "J" sticker of same color&foil.



7

Use PU transparent mounting adhesive in the applications of both J handle and aluminium edge profiles.





TECHNICAL INFORMATIONS

No	FEATURE	VALUE	RESULT (Super matt)	STANDART
1	Gloss level (60° angle)	-	5 GU	TS EN 14323
2	Scratch resistance	H	3H	TS 7385
3	Assessment of surface resistance to wet heat (85°C)	5	5 (No change)	TS EN 12721+A1:2014:02
4	Assessment of surface resistance to dry heat (70°C)	5	5 (No change)	TS EN 12722+A1:2014:02
5	Surface abrasion resistance	5	250 rev. (Class 4)	TS EN 14323 : 2021-12 6.9
6	Behavior towards impact loading by falling steel ball	5	2 (There is change)	TS EN 14323:2021-12 6.13
7	Test of water steam resistance	5	2 (There is change)	TS EN 14323:2021-21,Art. 6.10
8	Resistance to staining	5	5 (No change)	TS EN 14323 6.6
9	Assessment of surface resistance to chemical cold liquids (Acetic acid, acetone, ammonia solution, citric acid, cleaning agent, etc.)	5	5 (No change)	TS EN 12720:2009+A1:2014-02
10	Colorfastness to light	5	5. Grade	TS EN 15187
11	Thickness tolerance	-	± 0,30 mm	TS EN 324-1
12	Bow tolerance	-	3,5 mm / m	Gizir
13	Width and Length tolerance	-	± 5 mm / m	TS EN 324-1

- These values are weighted average of the test results.

- The test results of the 6th and 7th tests became the 2nd level out of the 5th level according to the product standard determined by TSE.



✉ info@gizir.com

🌐 gizir.com

Export Office & Showroom

📍 Barbaros Mah. Begonya Sok.
Nidakule Ataşehir Kuzey Sit.
No: 3/70 Ataşehir / İstanbul
☎ +90 (216) 519 33 73

Headquarters

📍 Organize Sanayi Bölgesi,
Çanakkale Cad. No:17 01350
Sarıçam / Adana
☎ +90 (322) 394 43 40 (pbx)